



NOTICE OF INTENDED INSTALLATION AND USE



THE ROSEN MULTI-MEDIA NAVIGATION SYSTEMS CONTAIN AN INTERNAL VIDEO PLAYER, WHICH IS NOT INTENDED FOR VIEWING BY THE DRIVER. THE VIDEO PLAYER IS DISABLED WHEN THE VEHICLE IS IN MOTION THROUGH A CONNECTION TO THE PARKING BRAKE.

THE INSTALLER OF THIS PRODUCT MUST INSURE THE VIDEO DISABLE CONNECTION IS WORKING PROPERLY PRIOR TO DELIVERY OF THE VEHICLE.

IMPROPER INSTALLATION COULD DISTRACT THE DRIVER OR INTERFERE WITH SAFE OPERATION OF THE VEHICLE, WHICH COULD RESULT IN SERIOUS INJURY OR DEATH, AND COULD ALSO VIOLATE STATE AND/OR FEDERAL LAW.

ROSEN ENTERTAINMENT SYSTEMS DISCLAIMS ANY LIABILITY FOR ANY BODILY INJURY OR PROPERTY DAMAGE THAT MAY RESULT FROM ANY IMPROPER OR UNINTENDED INSTALLATION AND/OR USE.

DS-VW0710 VW Series

	<p><u>STOP</u> Damage to the vehicle may occur Do not proceed until process has been completed</p>
	<p><u>CAUTION</u> Process must be carefully observed in order to reduce the risk of damage to the accessory or vehicle</p>
	<p><u>CRITICAL</u> Process must be carefully observed in order to ensure a quality installation</p>
	<p><u>TOOLS and EQUIPMENT</u> Specific tools and equipment recommended for this process</p>
	<p><u>SAFETY RISK</u> Observe safe practices, this process can be dangerous and there is a risk of personal injury</p>
	<p><u>TESTING and TROUBLESHOOTING</u> Content specific testing and troubleshooting points</p>

Installation Guide VW Series

PREPARING FOR THE INSTALLATION

Before you start, please read these critical steps below

STEP 1

**BEFORE YOU START THE INSTALLATION,
READ THIS GUIDE!**



VISIT

Rosen Dealer Central

For the latest Updates, Corrections and Technical Tips
about this product and installation
www.RosenDealerCentral.com



CHECK THE BATTERY

Test the battery voltage to make sure it's fully charged

This only takes seconds and can save hours of
troubleshooting later.

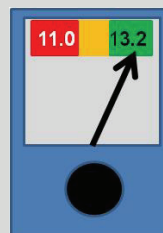

TURN THE VEHICLE

OFF

Keep the Vehicle Off during the installation to avoid setting
various Vehicle Faults



Keep the Vehicle OFF during the installation

Failure to follow this may cause the AIRBAG FAULT
SENSOR to become enabled. Dealer Service
Departments charge a significant fee to reset the Fault
Sensor.

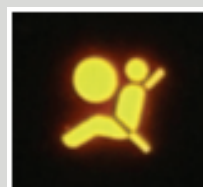

Installation Guide VW Series

REMOVE THE FACTORY RADIO

STEP 2

You will need to remove multiple interior trim components prior to removing the factory radio. The following steps will help guide you through this process.

Remove Upper Dash/Vent Trim

Use a thin pry tool to carefully lift the Upper grill. Use Caution, the plastic is fragile and excess force can break or damage trim



Remove the Inner Trim / Vent Components

Remove 3 x T-20 Torx screws to release the inner Trim / Vent components.



Remove the Radio Surround Trim

Remove 2 x T-20 Torx screws to release Radio Surround Trim



Remove the Radio Mounting Screws

Remove 4 x T-20 Torx screws to release the radio



Remove OEM Radio from Dash and Unplug Factory Harness

Carefully slide the radio out, and release the main connector block and antenna connectors

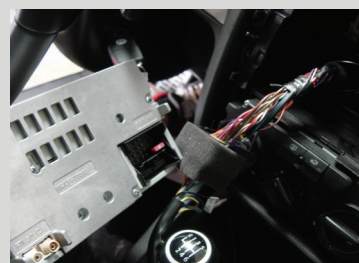

Installation Guide VW Series

LOCATING REMOTE COMPONENTS

STEP 3

You will need to mount the GPS and Optional Satellite Radio Antennas on the exterior of the vehicle. And mount the iPod Interface Connector in the vehicle. The following steps will help guide you through this process.

Use Caution around SRS Components

It is the **installer's responsibility** to ensure that the safety equipment in the vehicle is **NOT** adversely affected by installation of this system. Ensure that the routing of the harnesses do NOT obstruct airbags, SRS or other safety devices.



Mount the GPS and Sat Radio antenna in a location on the exterior of the Vehicle

Route the GPS harness away from other power harnesses in the vehicle.

This will help to ensure optimum performance of the GPS system.



Install the iPod interface connector in a location accessible to the end-user

Locate the iPod interface module in an area which can be serviced in the future.

The iPod cable is intended to be a serviceable item, which plugs into the iPod/Sat radio Interface Module.



INSTALL THE ROSEN NAVIGATION SYSTEM

STEP 4

You will need to prepare the Rosen Navigation System for installation in the vehicle.







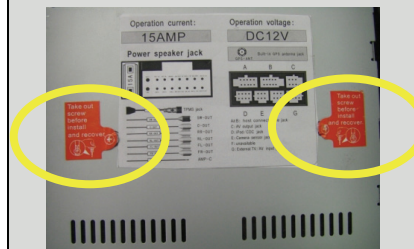

Remove the DVD Transport Screws

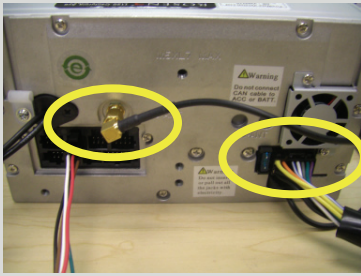
There are 2 x Phillips Transport Screws which protect the DVD Mechanism during transportation.

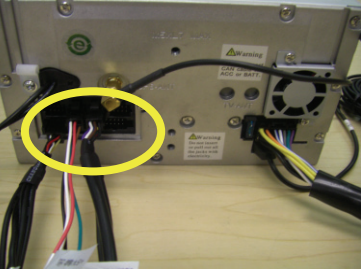
Transport Screws must be removed prior to installation.



Installation Guide VW Series

<p>Connect the Power and GPS Harnesses</p> <p>The GPS Harness must be tightened with a WRENCH to ensure it is properly seated.</p> <p><u>Failure to follow this step may result in poor GPS signal</u></p>		
<p>Connect Optional Harnesses such as iPod, Satellite Radio, Camera, Reverse Sensors</p> <p>These harnesses must be fully engaged prior to the system installation.</p> <p>See the Harness Diagrams for more information</p>		
<p>Prepare the Vehicle side harnesses for connection to the Rosen Harness</p> <p>Use care not to pinch or damage cables as this will cause performance issues/failures</p>		
<p>Engage all Connectors to the Factory Harnesses and attach the Rosen System using the previously removed Mounting Screws</p> <p>Attach the system with 4 x T-20 Torx Screws</p>		
<p>Turn the vehicle ON and confirm the unit is fully operational</p> <p>With the connectors Fully Engaged, turn the vehicle on and press the RESET for 5 seconds on the unit.</p>		
<p>Insert a DVD to confirm the Video Disable Circuit is properly Operating.</p> <p>The Video Disable is provided by the CANBus in most VW vehicles.</p> <p>However, in some vehicles the Brake Wire must be connected to the Park Brake Indicator Wire to complete a ground when the brake is engaged.</p>	<div data-bbox="919 1671 1243 1814" style="border: 1px solid black; padding: 5px;"> <p style="text-align: center;">Notice</p> <p>Some features are not intended for viewing by the Driver while the vehicle is in motion.</p> <p>For further details, please refer to the Owner's Manual</p> </div>	

Installation Guide VW Series

RE-INSTALL THE TRIM COMPONENTS

You will need to reinstall all trim components

STEP 5

Reinstall all Trim Components in the reverse order from Step 2

Prior to installing trim components, confirm that all clips are in good condition.

Replace any broken or damaged trim components or clips



Install the Inner Trim / Vent Components

Install 3 x T-20 Torx screws to attach the inner Trim / Vent components.



Install the Upper Trim / Vent Component

Use caution when installing the Upper Trim / Vent Component as it can easily be deformed or damaged.



ENABLE INSTALLER SETTINGS

You will need to select certain Installer Setting based on any Optional Equipment that you may have installed

STEP 6

Launch the Installer Setting Screen

From any screen with the Menu Button, follow these steps to display the Installer Setting Screen, select:

- 1) From any Screen, select "Menu"
- 2) From the Menu Screen, select "Settings"
- 3) Press "Keypad," Press "7253" and "Enter"



Installation Guide VW Series

Select the individual Settings as needed for the installed components

Selectable options vary by product and installation. Select the options as applicable for the installed optional components.



Perform Pre-Delivery Tests

You will need to perform several Pre-Delivery Tests to ensure customer satisfaction

STEP 7

Turn the vehicle ON and System ON

Confirm the unit starts up properly

Troubleshooting

- 1) Reset the System while the Vehicle is ON
- 2) Confirm all connectors are properly installed
- 3) Check the Vehicle and System Fuses



Select RADIO as the Source

Confirm that the AM and FM reception are as expected

Troubleshooting

- 1) Confirm both Antennas are properly connected.
- 2) Confirm the Factory Sat Antenna (green) has not been used
- 3) Reset the System



Select SATELLITE RADIO as the Source

Confirm Channel 001 is present after ~5 minutes

Troubleshooting

- 1) Confirm the SAT Radio is Turned ON in the Installer Settings
- 2) Confirm the antenna has unobstructed view of the Sky
- 3) Confirm the antenna is located on the outside of the vehicle



Select IPOD as the Source (if Equipped)

Confirm iPod is communicating a playback is OK

Troubleshooting

- 1) Confirm iPod Version Compatibility – not all are compatible
- 2) Confirm the harnesses are properly engaged
- 3) Reset the System



Installation Guide VW Series

<p>Select CD as the Source Confirm CD audio playback is OK</p> <p><u>Troubleshooting</u></p> <ol style="list-style-type: none"> 1) Confirm the Disc is Store Bought and in good condition 2) Reset the system 		
<p>Select DVD as the Source Confirm DVD video playback is OK</p> <p><u>Troubleshooting</u></p> <ol style="list-style-type: none"> 1) Ensure the Park Brake is set to view video 2) Confirm the Disc is Store Bought and in good condition 3) Reset the system 		
<p>Select MP3 as the Source Confirm MP3 playback is OK – Select Favorites</p> <p><u>Troubleshooting</u></p> <ol style="list-style-type: none"> 1) Confirm that a Test Track exists in the Favorites Folder 2) Reset the system 		
<p>Select Phone as the Source Confirm Phone Pairing is successful</p> <p><u>Troubleshooting</u></p> <ol style="list-style-type: none"> 1) Confirm the Phone has BT and is in discoverable mode 2) Confirm the Phone is compatible with the system 3) Reset the system 		
<p>Select NAV as the Source Confirm the Navigation loads and signal strength is OK</p> <p><u>Troubleshooting</u></p> <ol style="list-style-type: none"> 1) Confirm the antenna has an unobstructed view of the sky 2) Confirm the antenna is located on the outside of the vehicle 3) Confirm the antenna connection is properly tightened 		
<p>Select Reverse Camera (If Equipped) Confirm the backup camera screen shows in reverse</p> <p><u>Troubleshooting</u></p> <ol style="list-style-type: none"> 1) Confirm the Camera is set to ON in the Installer Settings 2) Confirm the Reverse Trigger wire is attached properly 3) Confirm the Camera is receiving 12VDC as required 		

Installation Guide VW Series

Service and Optional Parts List

<u>Part Number</u>	<u>Description</u>	<u>Part Number</u>	<u>Description</u>
DP-VW0711	Quick Reference Guide	DP-VW0712	Harness, Main Interconnect
DP-VW0714	Installation Guide	DP-1007	Harness, USB Adaptor
DP-1001	Manual, Owner's	DP-1008	Harness, AUX Out
DP-1003	Manual, Navigation	DP-1009	Harness, AUX IN
DP-1004	Remote Control	DP-1010	Harness, Sensors/Camera
DP-1023	Pin, Stylus	DP-1011	Harness, Dolby 5.1/Amp
DP-1020-H11	Card, SD w/ maps	DP-1013	Harness, iPod/Interface Box
DP-1022	Antenna, GPS	DP-1015	Harness, iPod Replacement
DP-1042	XM/iPod Multimedia Kit	DP-1051	Harness, Sirius Interface
DP-1035	Camera, Cylinder W/Mount	DP-1047	GPS Antenna Windshield Mount
DP-1055	Sirius/iPod Multimedia Kit	DP-1030	Sensors, Reverse Kit

Main Harness Diagram

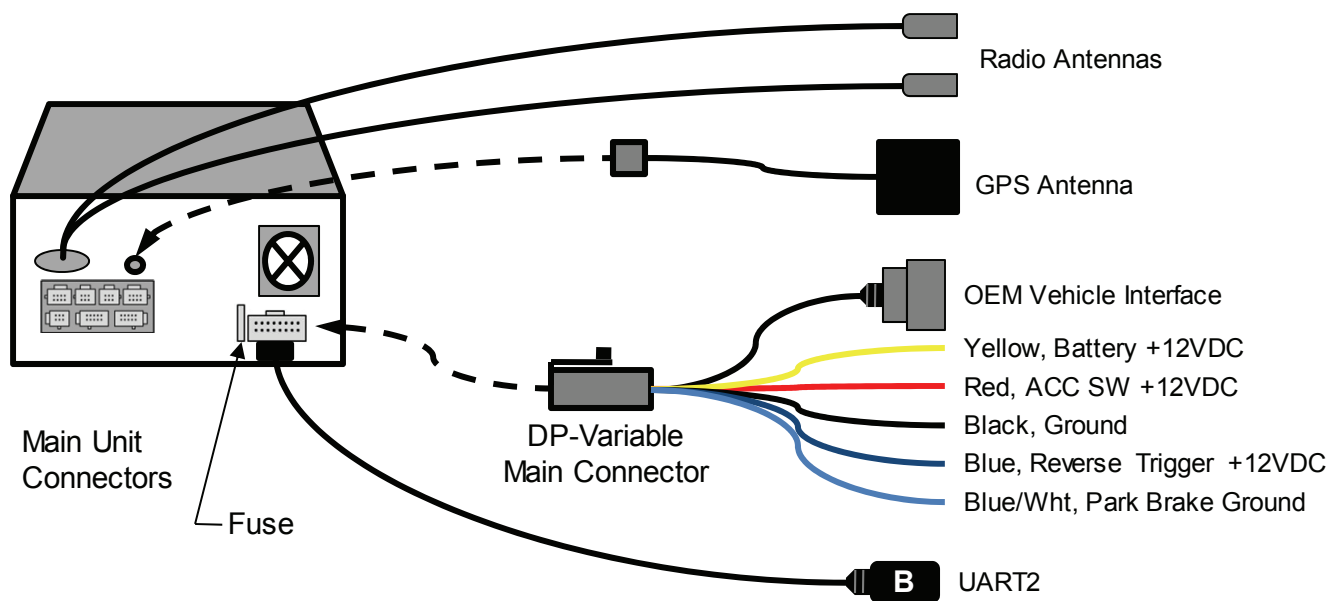

Installation Guide VW Series

Option Harness Diagram

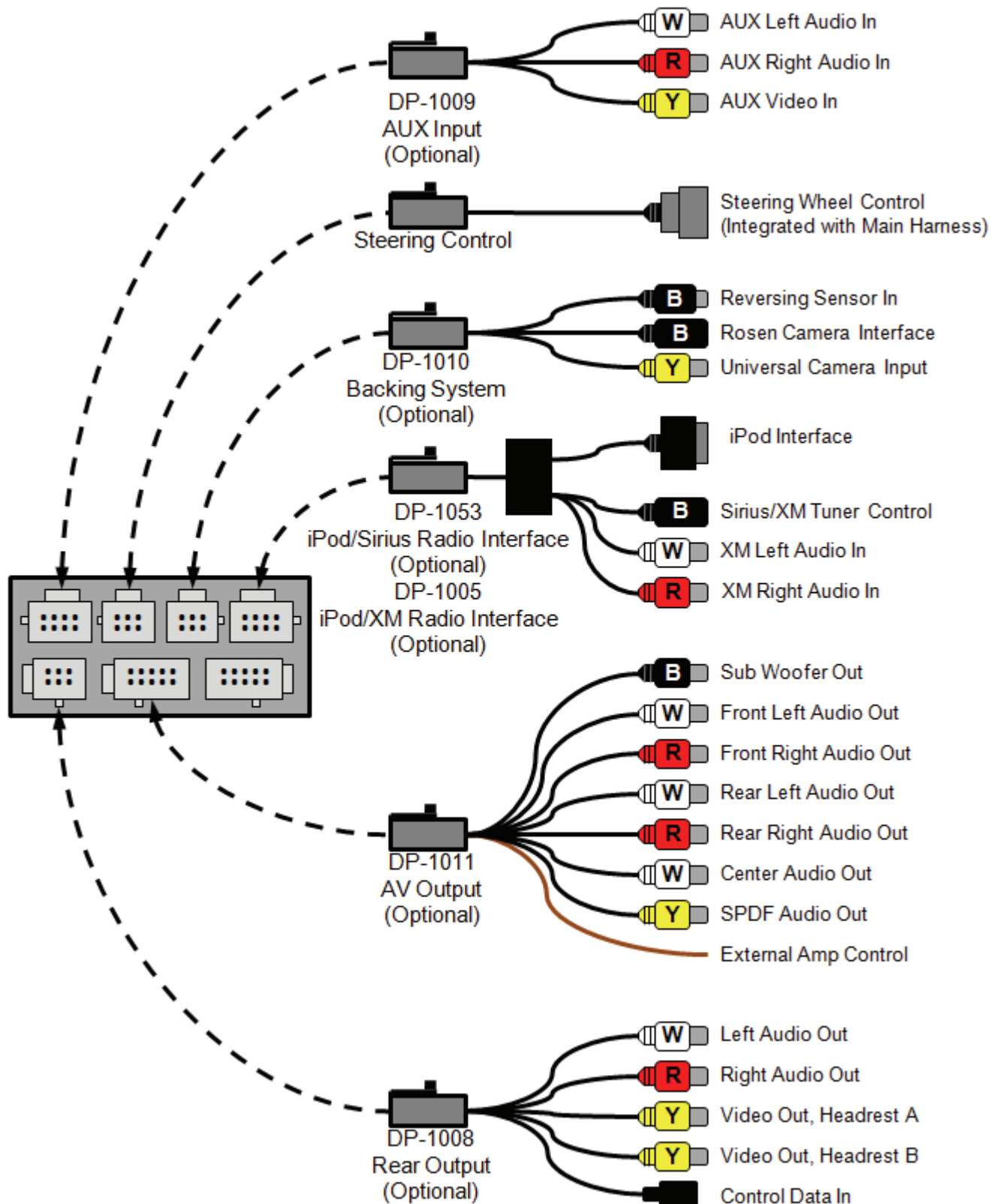

Installation Guide VW Series